

MODEL  
DLC1800  
1800lb/817kg CAPACITY  
PULLING WINCH

FRONT & SIDE VIEW

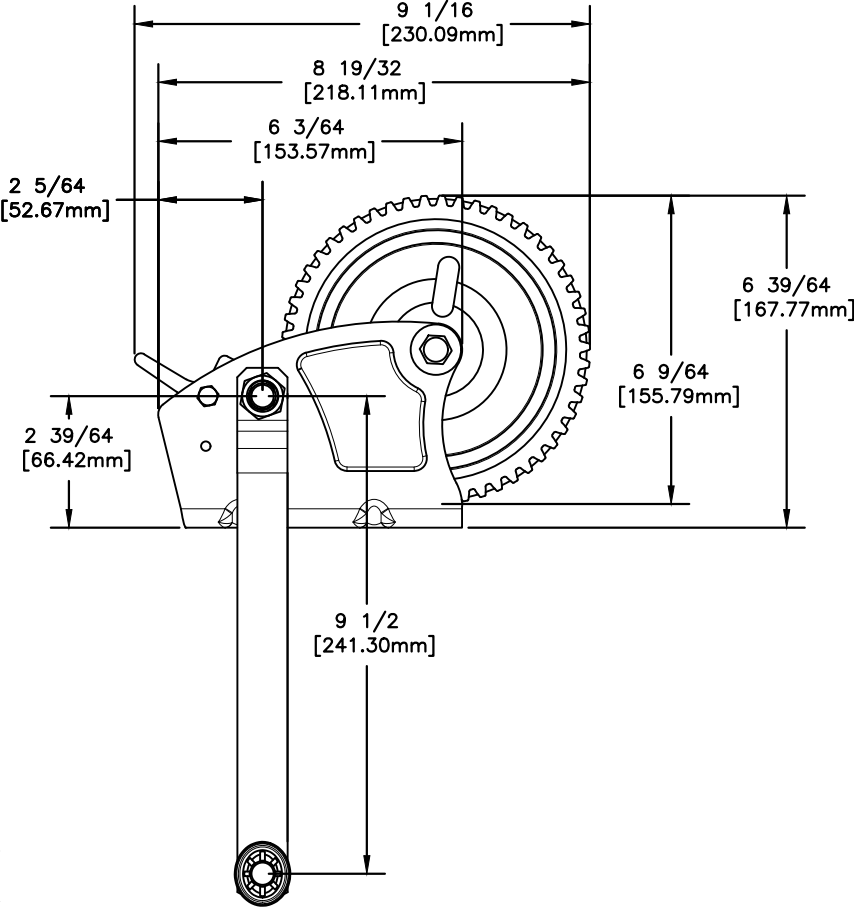

BASE HOLE PATTERN

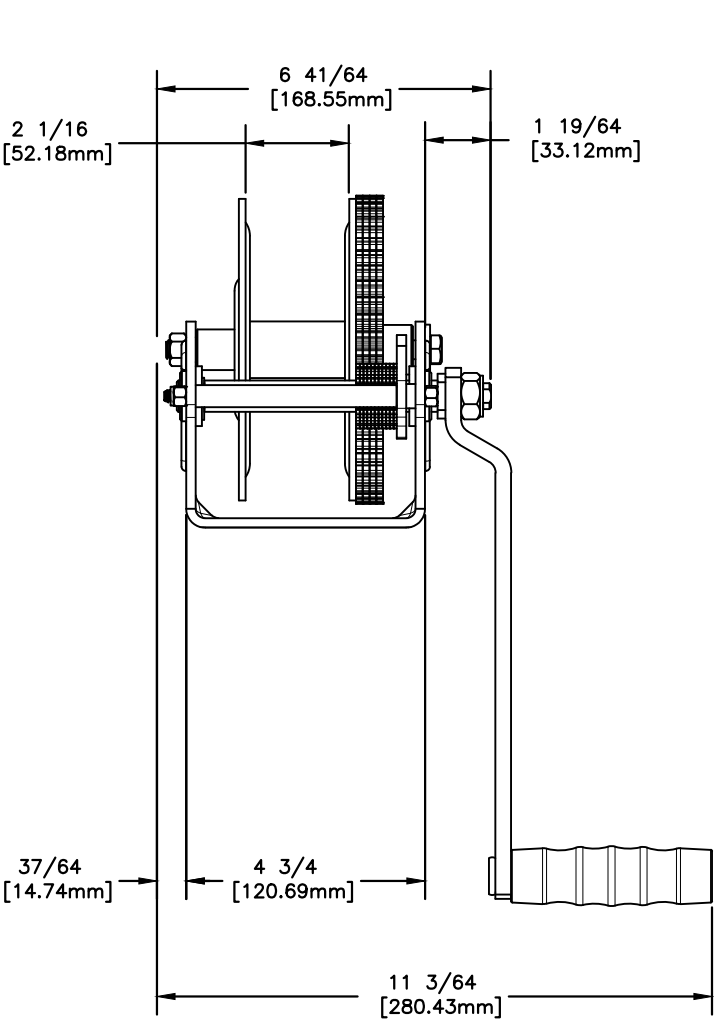